



Installation Guide

Hardie™ Fine Texture Cladding

Hardie™ Brushed Concrete Cladding

EXTERIORS

Australia October 2023

Make sure your information is up to date.

When specifying or installing Hardie™ products, ensure that you have the current technical information and guides.

If in doubt, or you need more information, visit www.jameshardie.com.au or Ask James Hardie™ on 13 11 03.

CONTENTS

1	INTRODUCTION	1
2	SAFE WORKING PRACTICES	2
	Warning	2
	Recommended safe working practices	2
	Storage and handling	2
3	DESIGN CONSIDERATIONS	2
	Framing	3
	Fasteners	3
4	HARDIE™ FINE TEXTURE AND BRUSHED CONCRETE CLADDING DESIGN	4
	Recommended Accessories	4
	Alternative Accessories	4
5	PRODUCTS AND ACCESSORY DETAILS	5
	Components	5
	Fasteners, Battens and Tapes	6
6	PANEL INSTALLATION - DIRECT FIX	8
7	PANEL INSTALLATION - CAVITY FIX	9
8	CONSTRUCTION DETAILS - DIRECT FIX	10
	Junction Details	10
	External Corner Details	11
	Internal Corner Details	12
	Window Details	12
9	CONSTRUCTION DETAILS - CAVITY FIX	13
	Junction Details	13
	External Corner Details	14
	Internal Corner Details	14
	Window Details	15
	Infills	16
	Columns	16
10	FINISHES AND MAINTENANCE	17
	Surface Preparation	17
	Painting	17
	Maintenance	17
10	PRODUCT INFORMATION	18

Made in Australia

SCOPE

This guide covers the use of Hardie™ Fine Texture Cladding and Hardie™ Brushed Concrete Cladding in a residential wall application over a seasoned timber wall frame or a light-gauge steel frame installed in a vertical upright application.

CODEMARK CERTIFICATION

The CodeMark Certification Scheme is a voluntary third-party building product certification scheme that authorises the use of new and innovative products in specified circumstances in order to facilitate compliance with Volume 1 and 2 of the NCC.

Hardie™ Fine Texture Cladding and Hardies™ Brushed Concrete Cladding has been certified under the CodeMark scheme (Certificate Number CM40302) and available at www.jameshardie.com.au. This certificate can be provided to building certifiers and other regulatory authorities to facilitate the assessment of the product compliance or used to verify the suitability of the product for certain applications.



The beauty of clean lines and designer finishes.

Hardie™ Fine Texture Cladding and Hardie™ Brushed Concrete Cladding are the latest innovation from James Hardie, bringing a tactile finish to the home exterior without the need for render, bricks or masonry.

The smooth, natural sand texture embedded into the surface of Hardie™ Fine Texture Cladding adds warmth and diffuses light for a fine matte finish across large facades, while the grained masonry texture of Hardie™ Brushed Concrete Cladding is soft and flowing working well in intimate spaces like entryways, courtyards and alfresco areas.

1 Introduction

Both Hardie™ Fine Texture and Brushed Concrete Cladding are a fibre cement panel embedded with high quality textures.

The shiplap joint on the long edges leaves a subtle V-joint. It removes the need for time-consuming set joints and specialty coatings that could be prone to cracking.

The panels are pre-sealed, and flush driven brad nails remove the need for patching. Simply apply regular exterior acrylic flat paint on-site (Refer to the Finishing section on page 17 for more information).



Renovation.

The texture is designed to match popular cement or acrylic render for a consistent match with the rest of the house.

New homes and townhouses.

Mix it with other cladding products by James Hardie to achieve design diversity.

Specifiers.

Ensure the information in these specifications is appropriate for the application you're planning. Undertake specific design and detailing for areas which fall outside the scope of these specifications.

Installers.

Ensure that you follow the design, moisture management and associated details and material selection provided by the designer and the Hardie™ Fine Texture Cladding and Hardie™ Brushed Concrete Cladding Installation Guide.

IMPORTANT NOTES

1. Failure to install, finish or maintain this product in accordance with applicable building codes, regulations, standards and James Hardie's written application instructions may lead to personal injury, affect system performance, violate local building codes, and void the Hardie™ product warranty.
2. All warranties, conditions, liabilities (direct, indirect or consequential) and obligations whether arising in contract, tort or otherwise other than those specified in the Hardie™ product warranty are excluded to the fullest extent allowed by law. For Hardie™ product warranty information and disclaimers about the information in this guide, visit www.jameshardie.com.au.
3. The builder must ensure the product meets aesthetic requirements before installation. James Hardie will not be responsible for rectifying aesthetic surface variations following installation.

2 Safe Working Practices

WARNING - DO NOT BREATHE DUST AND CUT ONLY IN WELL VENTILATED AREA

Fibre cement products manufactured by James Hardie contain sand, a source of respirable crystalline silica. **May cause cancer if dust from product is inhaled. Causes damage to lungs and respiratory system through prolonged or repeated inhalation of dust from product.** Intact fibre cement products are not expected to result in any adverse toxic effects. The hazard associated with fibre cement arises from the respirable crystalline silica present in dust generated by activities such as cutting, rebating, drilling, routing, sawing, crushing, or otherwise abrading fibre cement, and when cleaning up, disposing of or moving dust. When doing any of these activities in a manner that generates dust, follow Hardie™ instructions and best practices to reduce or limit the release of dust, warn others in the area and consider rotating personnel across the cutting task to further limit respirable silica exposure. If using a dust mask or respirator, use an AS/NZS1716 P1 filter and refer to Australian/New Zealand Standard 1715:2009 Selection, Use and Maintenance of Respiratory Protective Equipment for more extensive guidance and more options for selecting respirators for workplaces. For further information, refer to our installation instructions and Safety Data Sheets available at www.jameshardie.com.au. FAILURE TO ADHERE TO OUR WARNINGS, SAFETY DATA SHEETS, AND INSTALLATION INSTRUCTIONS MAY LEAD TO SERIOUS PERSONAL INJURY OR DEATH.

James Hardie Recommended Safe Working Practices

CUTTING OUTDOORS

1. Position cutting station so wind will blow dust away from the user or others in working area.
2. Warn others in the area to avoid dust.
3. Consider rotating personnel across cutting tasks to further limit respirable silica exposures.
4. Use one of the following methods based on the required cutting rate:
Best ■ Hardie™ knife ■ Hand guillotine ■ Fibreshear
Better ■ Position the cutting station in a well-ventilated area. Use a dust reducing circular saw equipped with Hardie™ Blade Saw Blade or comparable fibre cement blade and well maintained M-class vacuum or higher with appropriate filter for capturing fine (respirable) dust. Wear a properly-fitted, approved dust mask or respirator (minimum P1).

CUTTING INDOORS

- Cut only using Hardie™ knife, hand guillotine or fibreshears (manual, electric or pneumatic).
- Position cutting station in a well-ventilated area.

DRILLING/OTHER MACHINING

When drilling or machining you should always wear a P1 dust mask and warn others in the immediate area.

IMPORTANT NOTES

1. For maximum protection (lowest respirable dust production) James Hardie recommends always using best practice cutting methods where feasible.
2. NEVER use a power saw indoors or in a poorly ventilated area.
3. ALWAYS use a dust reducing circular saw equipped with a sawblade specifically designed to minimise dust creation when cutting fibrecement - preferably a sawblade that carries the Hardie™ Blade logo or one with at least equivalent performance - connected to a M class or higher vacuum.
4. NEVER dry sweep - Use wet suppression, or an M class vacuum or higher with appropriate filter.
5. NEVER use grinders.
6. ALWAYS follow tool manufacturers' safety recommendations.
7. ALWAYS wear a properly fitted, approved dusk mask, P1 or higher

DUST MASKS AND RESPIRATORS

As a minimum, an AS/NZS1716 P1 respirator must be used when doing any activity that may create dust. For more extensive guidance and options for selecting respirators for workplaces please refer to Australian/New Zealand Standard 1715:2009 "Selection, Use and Maintenance of Respiratory Protective Equipment". P1 respirators should be used in conjunction with the above cutting practices to minimise dust exposure. For further information, refer to Safety Data Sheet (SDS) available at www.jameshardie.com.au. If concern still exists about exposure levels or you do not comply with the above practices, you should always consult a qualified industrial hygienist or contact James Hardie for further information.

STORAGE AND HANDLING

To avoid damage, all Hardie™ building products should be stored with edges and corners of the product protected from chipping. Hardie™ building products must be installed in a dry state and protected from weather during transport and storage. The product must be laid flat under cover on a smooth level surface clear of the ground to avoid exposure to water, moisture, etc.

3 Design Considerations

All design and construction must comply with the appropriate requirements of the current National Construction Code (NCC) and other applicable regulations and standards.

Slab and Footings

The slab and footings on which the building is situated must comply with AS 2870 'Residential slabs and footings – Construction' and the requirements of the NCC.

Ground Clearances

Install Hardie™ Fine Texture and Brushed Concrete Cladding with a minimum 150mm clearance to the earth on the exterior of the building or in accordance with local building codes if greater than 150mm is required. Maintain a minimum 50mm clearance between the external cladding and roofs, decks, paths, steps and driveways.

Adjacent finished grade must slope away from the building in accordance with local building codes, typically a minimum slope of 50mm over the first metre.

Do not install external cladding such that it may remain in contact with standing water.

NOTE

Greater clearance may be required in order to comply with termite protection provisions, see below for more information.

Slab Treatment

For a high quality finish, James Hardie recommends considering the quality of the visible slab edge, and available treatments.

To terminate the bottom edge of the cladding, James Hardie provides two options - the Slim Base Starter which creates a crisp neat edge, and the Base Trim which creates a neat skirting board finish. The Base Trim option may hide poor quality slab edges.

Other treatments to consider include tanking the slab edge with suitable waterproofing, using insulated slab edges, or building French drains.

Termite Protection

The NCC specifies the requirements for termite barriers. Where the exposed slab edge is used as part of the termite barrier system, a minimum of 75mm of the exposed slab edge must be visible to permit ready detection of termite entry.

Structural Bracing

Hardie™ Fine Texture and Brushed Concrete Cladding can be installed to provide wall bracing against lateral forces due to wind. For further information, Contact James Hardie on 13 11 03.

Fire Rated Walls

Hardie™ Fine Texture and Brushed Concrete Cladding can be used as part of a fire rated wall when constructed with additional fire rated linings as specified in the Hardie™ Fire and Acoustically Rated Walls Application Guide and Technical Specification or the Hardie™ Smart Boundary Wall System Design Guide. The length of fasteners must be increased for the additional linings.

Moisture Management

It is the responsibility of designer or specifier to identify moisture related risks associated with any particular building design. Wall construction design must effectively manage moisture, accounting for both the interior and exterior environments of the building, particularly in buildings that have a higher risk of wind driven rain penetration or that are artificially heated or cooled.

In addition, all wall openings, penetrations, junctions, connections, window sills, heads and jambs must incorporate appropriate flashing and waterproofing. Materials, components and their installation that are used to manage moisture in framed wall construction must, at a minimum, comply with the requirements of relevant standards and the NCC.

Joint Location

Before starting the installation of Hardie™ Fine Texture and Brushed Concrete Cladding, plan the location of vertical and horizontal joints to follow the house design. To achieve this, consider aligning the joints with key building features such as windows or other opening, or work from the centerline out to the wall edge to achieve symmetry.

Weather Barrier

A suitable water control membrane must be installed under Hardie™ cladding in accordance with the AS/NZS 4200.2 'Pliable building membranes and underlays – Installation' and NCC requirements.

James Hardie has tested and certified the use of RAB™ Board for climate zones - 2-8 within Australia. Hardie™ Weather Barrier is a Class 4 vapour permeable membrane that delivers a triple-shield of protection to help against external weather penetration, internal condensation management and external heat penetration through its safe-glare reflective layer.

If using an alternate product in lieu of Hardie™ Weather Barrier or RAB™ Board or the project is located in a hot, humid area (Climate Zone 1), the designer must ensure that the product is fit for purpose and it has the following classification in accordance with AS/NZS 4200.1:2017 'Pliable building membranes and underlays – Materials':

TABLE 1

Weather Barrier Classification		
Climate Zone	Water Control Classification	Vapour Control Category
2-8	Water Barrier	Vapour Permeable (Class 3 or 4)
1		Vapour Barrier (Class 1 or 2)

Soft compressible insulation installed between the front of the wall studs and directly behind the external cladding can cause installation issues and is thus not recommended.

Flashing

All wall openings, penetrations, intersections, connections, window sills, heads and jambs must be flashed prior to cladding installation.

FRAMING

General

Hardie™ Fine Texture and Brushed Concrete Cladding panels are installed vertically either directly fixed to frame or installed to vertically oriented Hardie™ Cavity Battens or timber battens to provide a vented cavity, this can be done over either timber or steel frames. The general framing requirements for installation are given in Table 2. Please ensure the frame design considers correct load transfer between the different wall components.

Maximum stud, Hardie™ Cavity Batten and fastener spacing for Hardie™ Fine Texture and Brushed Concrete Cladding panels for wind load classifications of AS 4055 'Wind Loads for Housing' are given in Table 3.

FASTENERS

General

All nails must be driven flush. **Brad nails are recommended for best aesthetic finish.** For more information and advice, Contact James Hardie on 13 11 03.

Fastener Durability (Including Coastal Areas)

Fasteners must have the appropriate level of durability and be fully compatible with all other materials required for the intended project. In areas within 1km of a coastal area, areas subject to salt spray and other corrosive environments, class 4 fasteners must be used.

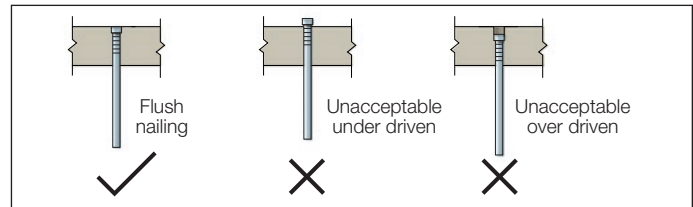

NAIL FASTENER DEPTH

TABLE 2

General Framing Requirements			
Type	Timber		Steel
Design	Use of timber framing must be in accordance with AS 1684 and the framing manufacturer's specifications		Use of steel framing must be in accordance with NASH standard for Residential and Low-Rise Steel Framing Part 1: Design Criteria and the framing manufacturer's specifications.
Durability	Timber used for house construction must have the level of durability appropriate for the relevant climate and expected service life. Reference AS 1684.2 'Residential timber-framed construction'.		The steel framing must have the appropriate level of durability required to prevent corrosion, particularly in coastal areas.
Tolerances	Ensure frame is square and work from a central datum line. A suggested maximum tolerance of between 3mm and 4mm in any 3000mm length of frame will give best results.		
Thermal Break Requirement	Not required.		For steel frames, the NCC Sections J3D6 and 13.2.5 Volumes 1 and 2 respectively, state for both residential and commercial buildings a thermal break with an R 0.2m2 K/W must be installed behind external cladding where the cladding and internal lining make direct contact with the same steel frame. Alternatively, vented cavity installation using minimum 70x350mm timber battens or off-stud Hardie™ Cavity Battens can be used in these applications.
Framing specifications			
	Direct Fix	Cavity Fix	Cavity Fix
BMT	NA		From 0.55 to 1.6mm.
Min. Stud Width	45mm at sheet edges. 35mm at intermediates.	35mm	Min. 32mm
Min. Stud Depth	70mm	70mm	64mm
Max. Nogging spacing	1350mm	1350mm for on stud batten fixing. 800mm for off stud batten fixing.	1350mm when battens are fixed on stud or 800mm when fixed off stud
Battens	N/A	Hardie™ Cavity Battens or minimum MGP10 70 x 35mm timber battens	Hardie™ Cavity Battens or minimum MGP10 70 x 35mm timber battens

TABLE 3

Maximum Stud, Hardie™ Cavity Batten or timber batten & fastener spacing for Hardie™ Fine Texture and Brushed Concrete Cladding in AS4055 Wind Classification							
Wind Classification	Stud and cavity batten or timber batten spacing	Only required for cavity fix				Sheet Fastener Spacing (Except Brad Nails)	Sheet Fastener Spacing (Brad Nails)
		Can be fixed off stud?		Batten fastener spacings			
		Hardie™ Cavity Battens	Timber Battens	Hardie™ Cavity Battens	Timber Battens		
N1, N2, N3/C1	600	Yes	Yes	300	300	200	125
N4/C2	600	No	No	200	200	200	125*
N5/C3	450	No	No	200		150	
N6/C4	300	No	No	200		125	

NOTE - When using brad nails:

- Refer to the accessories page for brad nails options.

NOTE - Off-stud cavity installation:

- When fixing Hardie™ Cavity Battens or timber battens offstud, noggings must be spaced based on the maximum batten span as described on Table 4.

* Only suitable when fixing to Hardie™ Cavity Battens or timber battens. Not suitable for direct fix to frame.

TABLE 4

Maximum span for Hardie™ Cavity Batten or timber batten			
Batten	Dimensions (mm)	Max. Span (mm)	
		Timber Frame	Steel Frame
Hardie™ Cavity Batten	70 x 19	800	800*
Timber Battens	70 x 35	1350*	800*

NOTES:

*Requires using two nails per fixing point when installing the battens off-stud. Refer to the Product and Accessories Details on page 7 for fastener and fixing requirements.

A continuous bead of Hardie™ Joint Sealant is required between the vertical battens and the back of the cladding in all cases.

4 Hardie™ Fine Texture and Brushed Concrete Cladding Design



1. Panel Layout

OPTION 1 Align with Centre
Best for symmetrical facades or strong geometries.

OPTION 2 Features
Best for asymmetrical facades with strong features.

OPTION 3 Run from Edge
Best for broadwalls.

Design Lead Accessories

Functional Accessories

2. External Corner

Hardie™ 9mm Aluminium External Slimline Corner

A sleek external corner with a sharp, minimal edge. It holds the panels tight with just 3.5mm of coverage.

Product Code: 306102



Hardie™ 9mm Aluminium External Square Corner

Aluminium extrusion that creates a square edge in external corners.

Product Code: 306100



3. Internal Corner

Hardie™ 9mm Aluminium Internal Concave Corner

A concave internal corner that gives 10mm of cover to conceal panel edges.

Product Code: 306103

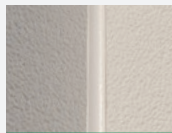

Hardie™ 9mm Aluminium Internal Corner

A sleek squared internal corner for a strong clean line.

Product Code: 305520



4. Horizontal Jointer

Hardie™ 9mm Aluminium Recessed Horizontal Jointer

A recessed horizontal jointer that creates a 6mm horizontal shadow line.

Product Code: 306190
Connector Product Code: 306191

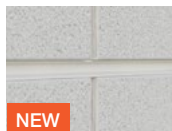

Hardie™ 9mm Aluminium Horizontal Express Jointer

A horizontal jointer that creates a 6mm horizontal shadow line whilst concealing the edge of the bottom panels.

Product Code: 306104
Connector Product Code: 306110



5. Base Junction

Hardie™ 9mm Aluminium Base Slimline Starter

Aluminium base trim that creates a neat edge to the cladding whilst improving installation by supporting the bottom of the panel.

Product Code: 306192
Connector Product Code: 306193



Hardie™ 9mm Aluminium Base Trim

A elegant trim used to cover the slab edges or as a detail under balconies and cantilevers.

Product Code: 306105
Connector Product Code: 306111





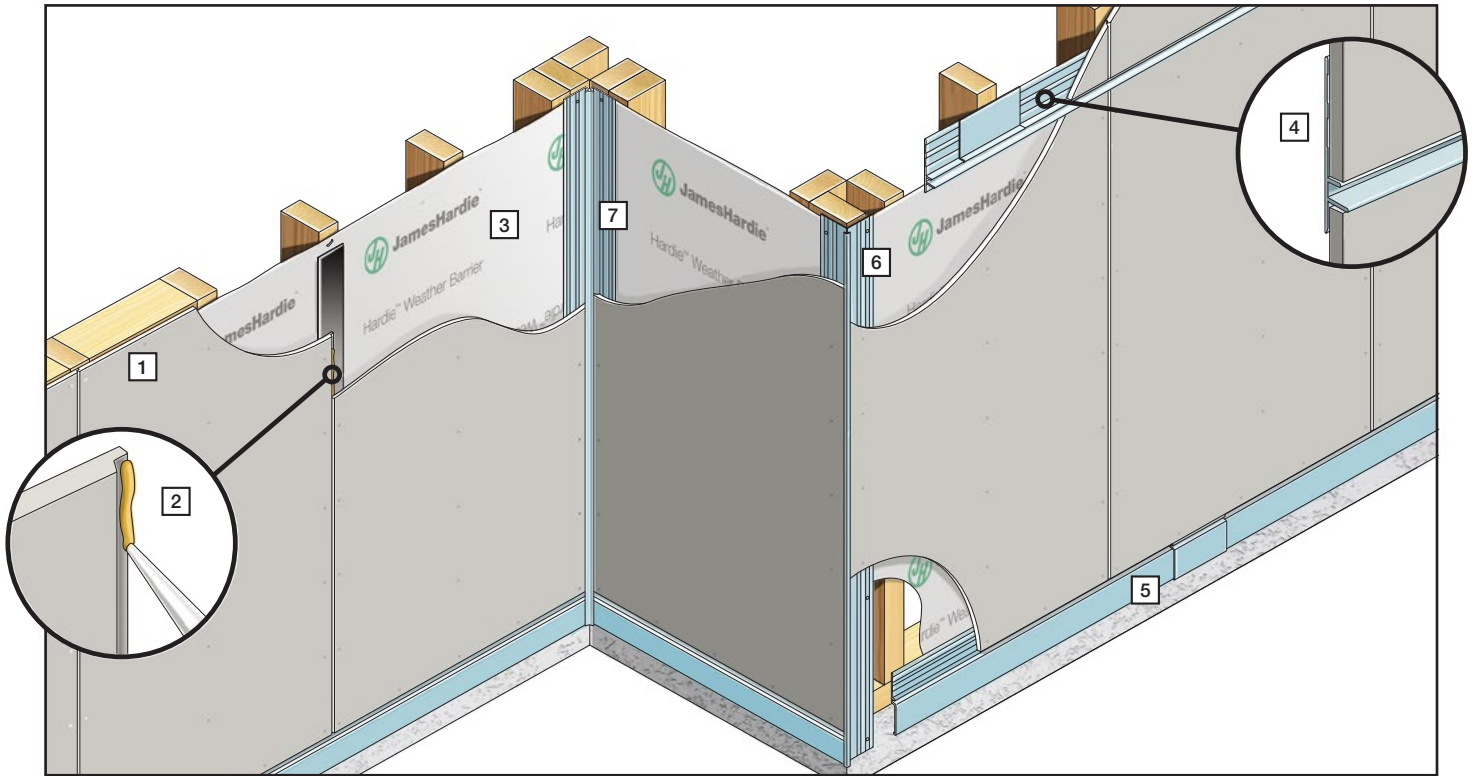

5 Products and Accessory Details

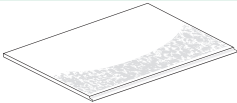
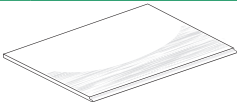

COMPONENTS

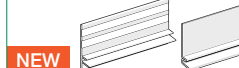

1	Hardie™ Fine Texture Cladding (8.5mm thick)	Product Code	Length (mm)	Width (mm)	Mass (kg)	Pack Size	Coverage (m²)
 <p>Pre-sealed and ready to paint textured panel with a shiplap V-shaped joint along the two vertical edges.</p>	405252	2440	1200	38	40	2.92	
	405255	2750	1200	43	40	3.30	
	405253	3000	1200	47	40	3.60	
	405254	3600	1200	56	30	4.32	
1	Hardie™ Brushed Concrete Cladding (8.5mm thick)	Product Code	Length (mm)	Width (mm)	Mass (kg)	Pack Size	Coverage (m²)
 <p>Pre-sealed and ready to paint textured panel with a shiplap V-shaped joint along the two vertical edges.</p>	405310	2440	1200	38	40	2.92	
	405311	2750	1200	43	40	3.30	
	405312	3000	1200	47	40	3.60	
	405309	3600	1200	56	30	4.32	

Weather Barrier Options

2 Hardie™ Joint Sealant  General purpose polyetherane exterior grade joint sealant. Pack Size: 20/Box. Product Code: 305534 300ml Cartridge Product Code: 305672 600ml Sausage Coverage: 2.67m/100ml (5mm dia bead)	3 Hardie™ Weather Barrier  Water barrier and vapour permeable membrane. Unit size: 2.75 x 30m. Pack Size: 1 Each. Product Code: 305664 Coverage: 85.5m² per roll	3 RAB™ Board  Airtight, weatherproof, vapour permeable and non-combustible rigid 6mm fibre-cement sheathing. 40 per pack 1200 x 2450mm Prod Code: 402980 1200 x 2750mm Prod Code: 405131 1200 x 3000mm Prod Code: 402981	4 Hardie™ 9mm Aluminium Horizontal Express Jointer  A horizontal jointer that creates a 6mm horizontal shadow line whilst concealing the edge of the bottom panels. Product Code: 306104. Connector Product Code: 306110. Coverage: Length of horizontal joints / 3000mm	4 Hardie™ 9mm Aluminium Recessed Horizontal Jointer  NEW A recessed horizontal jointer that creates a 6mm horizontal shadow line. Product Code: 306190 Connector Product Code: 306191 Coverage: Length of horizontal joints / 3000mm
---------------------------------------------------------------------------------------------------------------------------------------------------------------------------------------------------------------------------------------------------------------------------------------------------------------------------------------	-------------------------------------------------------------------------------------------------------------------------------------------------------------------------------------------------------------------------------------------------------------------------------	------------------------------------------------------------------------------------------------------------------------------------------------------------------------------------------------------------------------------------------------------------------------------------------------------------------------------------------	-------------------------------------------------------------------------------------------------------------------------------------------------------------------------------------------------------------------------------------------------------------------------------------------------------------------------------------------------------------------------------------------	------------------------------------------------------------------------------------------------------------------------------------------------------------------------------------------------------------------------------------------------------------------------------------------------------------------------------------------------------------------

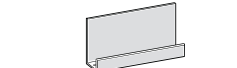

Horizontal Flashing Options

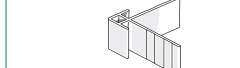
Base Options

5 Hardie™ 18mm PVC Cavity Vent Strip  A perforated PVC extrusion used at the bottom of walls. Only required if using Hardie™ Cavity Battens. 3000mm long. Pack Size: 25 Product Code: 305555 Coverage: Length of wall / 3000mm	5 Hardie™ 9mm Aluminium Base Trim  A elegant trim used to cover the slab edges or as a detail under balconies and cantilevers. Product Code: 306105 Connector Product Code: 306111	5 Hardie™ 9mm Aluminium Base Slimline Starter  NEW Aluminium base trim that creates a neat edge to the cladding whilst improving installation by supporting the bottom of the panel. Product Code: 306192 Connector Product Code: 306193	6 Hardie™ 9mm Aluminium External Square Corner  Aluminium extrusion that creates a square edge in external corners. Pack Size: 5. Product Code: 306100 Coverage: Height of wall x no. of external corners / 3000mm	6 Hardie™ 9mm Aluminium External Slimline Corner  A sleek external corner with a sharp, minimal edge. It holds the panels tight with just 3.5mm of coverage. Product Code: 306102 Coverage: Length of horizontal joints / 3000mm
-----------------------------------------------------------------------------------------------------------------------------------------------------------------------------------------------------------------------------------------------------------------------------------------------------------------------------------------	-------------------------------------------------------------------------------------------------------------------------------------------------------------------------------------------------------------------------------------------------------------------------------------------------	--------------------------------------------------------------------------------------------------------------------------------------------------------------------------------------------------------------------------------------------------------------------------------------------------------------------------------------------------------------	----------------------------------------------------------------------------------------------------------------------------------------------------------------------------------------------------------------------------------------------------------------------------------------------------------------------------------	-------------------------------------------------------------------------------------------------------------------------------------------------------------------------------------------------------------------------------------------------------------------------------------------------------------------------------------------------

External Corner Options

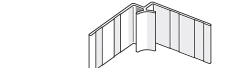
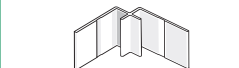
Internal Corner Options

7 Hardie™ 9mm Aluminium Internal Concave Corner  A concave internal corner that gives 10mm of cover to conceal panel edges. Product Code: 306103 Coverage: Length of horizontal joints / 3000mm	7 Hardie™ 9mm Aluminium Internal Corner  A sleek squared internal corner for a strong clean line. 3000mm long. Pack Size: 5. Product Code: 305520 Coverage: Height of wall x no. of internal corners / 3000mm	8 Hardie™ Corner Flashing  Manufactured using COLORBOND® steel, used behind cladding at internal and external corners. 75 x 75mm. 3000mm long. Pack Size: 5. Product Code: 305564. Coverage: Height of clad walls x no. of corners / 3000mm	9 Hardie™ Axent™ Trim  Material composite trim used for box corners and as decorative trim around windows and doors. For internal corners: 45 X 38mm 4200mm long. Product Code: 403626. For external corners: 45 X 19mm 4200mm long. Product Code: 404662
-------------------------------------------------------------------------------------------------------------------------------------------------------------------------------------------------------------------------------------------------------------------------------------------------------------	-------------------------------------------------------------------------------------------------------------------------------------------------------------------------------------------------------------------------------------------------------------------------------------------------------------------------	----------------------------------------------------------------------------------------------------------------------------------------------------------------------------------------------------------------------------------------------------------------------------------------------------------------------------------------------------	-------------------------------------------------------------------------------------------------------------------------------------------------------------------------------------------------------------------------------------------------------------------------------------------------------------------------------------------------------------------

† All dimensions and masses are approximate and subject to manufacture tolerances.

5 Products and Accessory Details cont.

Hardie™ Fine Texture and Brushed Concrete Cladding can be installed over timber frames, steel frames or other rigid substrates such as brick wall. This can be by direct fix to frame (for timber frames only), over Hardie™ Cavity Battens or 70 X 35mm timber battens. The required components will vary depending on the the fixing method and substructure.

OPTION 1: DIRECT FIX - TIMBER FRAME

	<p>8 Hardie™ Foam Back Sealing Tape</p> <p>Installed under sheet vertical joints to improve water tightness. 50mm wide 25mtr long roll. Pack Size: Each Product Code: 304560</p>	<p>9 ND 50mm Stainless Steel Brad Nail*</p> <p>14 gauge x 50mm ND 304 stainless steel nail for fixing panels to timber framing. Not supplied by James Hardie.</p>	<p>Gun Nail*</p> <p>Only required in high wind areas. 2.8 x 40mm minimum class 3 nail with a minimum 6mm head diameter to be used with gun nails. Not supplied by James Hardie.</p>	<p>Fibre Cement Nail*</p> <p>Only required in high wind areas. 2.8 x 40mm corrosion resistant fibre cement nail for fixing panels onto timber stud frame. Not supplied by James Hardie.</p>
--	-------------------------------------------------------------------------------------------------------------------------------------------------------------------------------------------------	------------------------------------------------------------------------------------------------------------------------------------------------------------------------------	-----------------------------------------------------------------------------------------------------------------------------------------------------------------------------------------------------------	-------------------------------------------------------------------------------------------------------------------------------------------------------------------------------------------------------------------

OPTION 2: CAVITY FIX - TIMBER FRAME

	<p>12 Battens</p>	<p>13 Nails to fix batten to frame*</p>	<p>14 Brad Nails* to fix cladding to battens</p>	<p>14 Fibre Cement Nails* to fix cladding to battens</p>
<p>When using Hardie™ Cavity Battens</p>	<p>Fibre cement batten used to fix external cladding to steel or timber frame. Pack Size: 96 Size: 70 x 19 x 3000mm. Product Code: 405307</p>	<p>2.8 x 65mm long ring shank nail or 75 x 2.8mm D or round head galvanised smooth shank nail. Not supplied by James Hardie.</p>	<p>25mm DA or C 16-gauge 304 stainless steel brad nails. Not supplied by James Hardie. Apply continuous Hardie™ Joint Sealant between the batten and cladding.</p>	<p>Only required in high wind areas. 2.8 x 40mm corrosion resistant fibre cement nail. Not supplied by James Hardie.</p>
<p>When using 70 x 35mm Timber Battens</p>	<p>Timber batten used to fix external cladding to steel or timber frame. Not supplied by James Hardie.</p>	<p>Two 75 x 3.06mm D Head Class 3 nails per fixing.</p>	<p>25mm DA or C 16-gauge 304 stainless steel brad nails. Not supplied by James Hardie. Apply continuous Hardie™ Joint Sealant between the batten and cladding.</p>	

OPTION 3: CAVITY FIX - STEEL FRAME

	<p>12 Battens</p>	<p>15 Screws to fix batten to frame*</p>	<p>14 Brad Nails* to fix cladding to battens</p>	<p>14 Fibre Cement Nails* to fix cladding to battens</p>
<p>When using Hardie™ Cavity Battens</p>	<p>Fibre cement batten used to fix external cladding to steel or timber frame. Pack Size: 96 Size: 70 x 19 x 3000mm. Product Code: 405307</p>	<p>Two Hardie™ Drive Screws - Class 3 self-tapping wing-tipped screw for fastening to 0.5mm to 1.6mm BMT light gauge steel frames. 1000 per box. Product Codes: 305984 (loose) 305982 (collated).</p>	<p>25mm DA or C 16-gauge 304 stainless steel brad nails. Not supplied by James Hardie. Apply continuous Hardie™ Joint Sealant between the batten and cladding.</p>	<p>Only required in high wind areas. 2.8 x 40mm corrosion resistant fibre cement nail. Not supplied by James Hardie.</p>
<p>When using 70 x 35mm Timber Battens</p>	<p>Timber batten used to fix external cladding to steel or timber frame. Not supplied by James Hardie.</p>	<p>Two 10-24 x 65mm Class 3 self-drilling CSK-Head screws per fixing.</p>	<p>25mm DA or C 16-gauge 304 stainless steel brad nails. Not supplied by James Hardie. Apply continuous Hardie™ Joint Sealant between the batten and cladding.</p>	

OPTION 4: CAVITY FIX - BRICK WALL

	<p>12 Battens</p>	<p>15 Screws to fix battens to brick wall</p>	<p>14 Brad Nails* to fix cladding to battens</p>	<p>14 Fibre Cement Nails* to fix cladding to battens</p>
<p>When using Hardie™ Cavity Battens</p>	<p>Fibre cement batten used to fix external cladding to steel or timber frame. Pack Size: 96 Size: 70 x 19 x 3000mm. Product Code: 405307</p>	<p>DeWalt 6mm Blue-Tip 2 Screw-Bolt™ with a minimum embedment of 40mm.† Not supplied by James Hardie.</p>	<p>25mm DA or C 16-gauge 304 stainless steel brad nails. Not supplied by James Hardie. Apply continuous Hardie™ Joint Sealant between the batten and cladding.</p>	<p>Only required in high wind areas. 2.8 x 40mm corrosion resistant fibre cement nail. Not supplied by James Hardie.</p>
<p>When using 70 x 35mm Timber Battens</p>	<p>Timber batten used to fix external cladding to steel or timber frame. Not supplied by James Hardie.</p>	<p>DeWalt 6mm Blue-Tip 2 Screw-Bolt™ with a minimum embedment of 40mm.† Not supplied by James Hardie.</p>	<p>25mm DA or C 16-gauge 304 stainless steel brad nails. Not supplied by James Hardie. Apply continuous Hardie™ Joint Sealant between the batten and cladding.</p>	

5 Products and Accessory Details cont.

Accessories

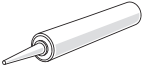
Exterior Water Based Gap Filling Agent

Recommended sealers include Selleys® No More Gaps - Exterior/Weatherboard or Polyfilla® - Large Cracks.

Tools

Hardie™ Blade Saw Blade 185mm diameter

Poly-diamond blade for Hardie™ fibre cement. Product Code: 300660 Pack Size: 1 each.

Dust-Reducing Saw with M class or higher vacuum extraction

Dust reducing saw with a Hardie™ Blade saw blade. Makita® 5057KB / Hitachi® C7YA.

Drop Saw*

Drop saw with an aluminium blade. *Not to be used for cutting Hardie™ Cladding.

* In coastal areas and other corrosive environments class 4 fasteners must be used. All other areas require minimum class 3.

† A structural engineer must determine whether the substrate is adequate to hold the proposed anchors, Hardie™ Cavity Batten or Timber Batten and the Hardie™ Cladding Loads. The anchor bolt connecting the battens to the concrete or masonry wall shall have a working load capacity of 0.7kN, equivalent to an Ultimate Limit State phi-R capacity of 1.05kN.

6 Panel Installation Process* - Direct Fix

STEP 1

Plan the location of sheet joints to align with the house design.

Consider working from the centerline out to the wall edge to achieve symmetry, or

Align the joints with key features of the house such as windows

STEP 2

Ensure your frame is square, maximum tolerance of 4mm in 3000mm length

Refer to Table 3 for maximum stud spacing

STEP 3

Install the required corrosion resistant flashing over windows and other openings.

Fix at 300mm centres

Corrosion resistant flashing with min. 75mm upstand

STEP 4

Install Hardie™ Weather Barrier

Overlap Hardie™ Weather Barrier 150mm at all horizontal joints and one stud bay at all vertical joints.

Extend min. 150mm around corners

Refer to the Hardie™ Weather Barrier Technical Data Sheet for further information

Galvanised staple fastener every 450mm per stud

STEP 5

Behind every vertical sheet joint, fix a continuous strip of 50mm EPDM foam back sealing tape to the Hardie™ Weather Barrier along the stud

STEP 6

Fix at max. 300mm centres (10mm min. clearance from the edge)

Install the corner accessories extending them by 60mm below the bottom plate. The bottom edge of the corner accessories must be at least 90mm from the ground.

STEP 7

When using the Slimline corners, the base flashing must be cut at 45 degrees.

Install selected base option (trim or Slimline Starter), sliding it into the corner accessories

STEP 8

Fix the first sheet along the perimeter and to each intermediate stud

50mm min. clearance at corners

Refer to Table 3 for fastener spacings

Centre of stud

3 mm

18 mm

STEP 9

Apply a continuous 4mm diameter bead of Hardie™ Joint Sealant to the edge of the shiplap and fix the subsequent boards along the perimeter and to intermediate studs. Repeat the process to the following boards. Wipe any excess sealant from joint.

Centre of stud

3 mm

18 mm

STEP 10

When using the Slimline Corner, the panels must be cut at 45 degrees

Apply a continuous bead of sealant vertically into the corner accessory. Slide the Hardie™ Fine Texture or Brushed Concrete Cladding panels into the accessory.

45°

STEP 11

Apply a continuous 4mm diameter bead of Hardie™ joint sealant to the edge of the panel and install the horizontal jointer

When using the Slimline corners, the horizontal jointer flashing must be cut at 45 degrees.

300mm

Slimline Corner

45°

Horizontal jointer

STEP 12

Paint the wall with an exterior acrylic paint within 3 months of being fixed or within 7 days if located within 1km of a coastal area or corrosive environment

If patching is required use a gap filling agent and a sponge to mimic the texture of the surface and do not sand the wall. Ensure to refer to Finishing section on page 17 for full information.

*This is an overview of the installation process only. It is not a substitute for reviewing this document in its entirety prior to installation.

7 Panel Installation Process* - Cavity Fix

STEP 1 Plan the location of sheet joints to align with the house design.

Consider working from the centerline out to the wall edge to achieve symmetry, or Align the joints with key features of the house such as windows

STEP 2 Ensure your frame is square, maximum tolerance of 4mm in 3000mm length

Max. 800mm centres when fixing cavity battens off-stud
Refer to Table 3 for maximum stud spacing

STEP 3 Install the required corrosion resistant flashing over windows and other openings.

Fix at 300mm centres
Corrosion resistant flashing with min. 75mm upstand

STEP 4 Install Hardie™ Weather Barrier

Overlap Hardie™ Weather Barrier 150mm at all horizontal joints and one stud bay at all vertical joints.
Extend min. 150mm around corners

Refer to the Hardie™ Weather Barrier Technical Data Sheet for further information
Galvanised staple fastener every 450mm per stud

STEP 5 Install the Hardie™ PVC Cavity Vent Strip

Fix at 600mm centres maximum, with 10mm edge clearance.
Hardie™ PVC cavity vent mitted at corners and kept clear of debris. Do not insert Hardie™ Cavity Batten into the vent strip.

STEP 6 Install the cavity battens (must be fixed off-stud in steel frames)

45° cut
Hardie™ Joint Sealant
Hardie™ Cavity Batten or timber batten
20 mm min.
Refer to Table 3 for fastener spacing

STEP 7 Install corner accessories as required. For alternative corners refer to Detailing section

Fix at max. 300mm centres (10mm min. clearance from the edge)

Install the corner accessories extending them 60mm below the bottom plate. The bottom edge of the corner accessories must be at least 90mm from the ground.

STEP 8 When using the Slimline corners, the base flashing must be cut at 45 degrees.

Install base flashing, sliding it into the corner accessories

STEP 9 Apply Hardie™ Joint Sealant over the cavity battens or timber battens and fix the first sheet along the perimeter and to each intermediate stud

50mm min. clearance at corners
Refer to Table 3 for fastener spacings

STEP 10 Apply a continuous 4mm diameter bead of Hardie™ Joint Sealant to the edge of the shiplap and fix the subsequent boards along the perimeter and to intermediate studs. Repeat the process to the following boards. Wipe any excess sealant from joint.

STEP 11 Apply a continuous 4mm diameter bead of Hardie™ joint sealant to the edge of the panel and install the horizontal jointer

When using the Slimline corners, the horizontal jointer flashing must be cut at 45 degrees.

STEP 12 Paint the wall with an exterior acrylic paint within 3 months of being fixed or within 7 days if located within 1km of a coastal area or corrosive environment

If patching is required use a gap filling agent and a sponge to mimic the texture of the surface and do not sand the wall. Ensure to refer to Finishing section on page 17 for full information.

*This is an overview of the installation process only. It is not a substitute for reviewing this document in its entirety prior to installation.

8 Construction Details - Direct Fix

JUNCTION DETAILS

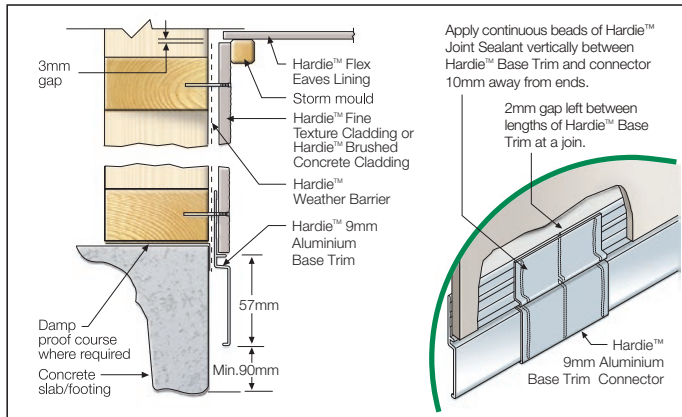

FIGURE 1 SLAB/EAVE JUNCTION DETAIL

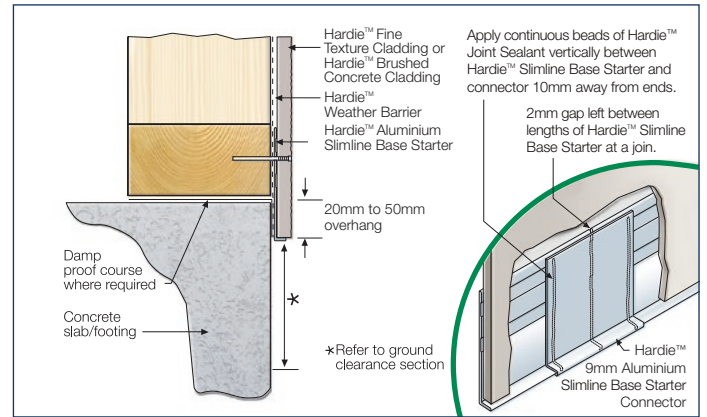

FIGURE 2 ALTERNATIVE SLAB JUNCTION

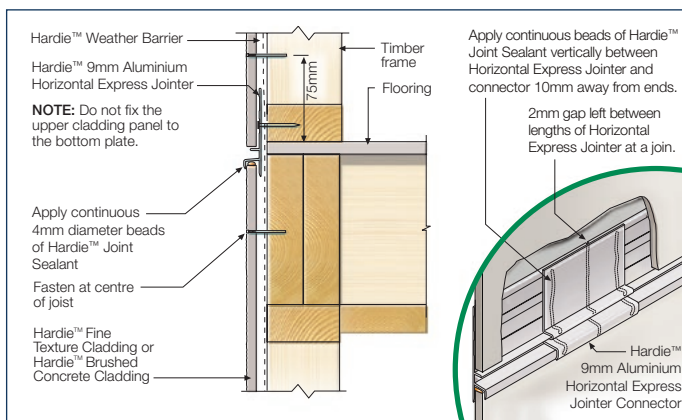

FIGURE 3 UPPER FLOOR JUNCTION OPTION 1

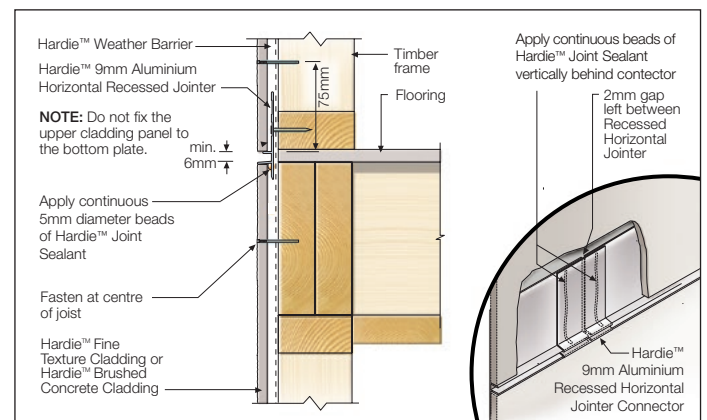

FIGURE 4 UPPER FLOOR JUNCTION OPTION 2

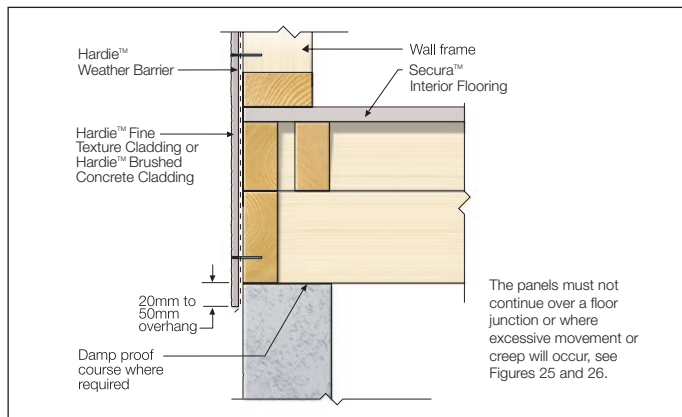

FIGURE 5 LOWER FLOOR JUNCTION

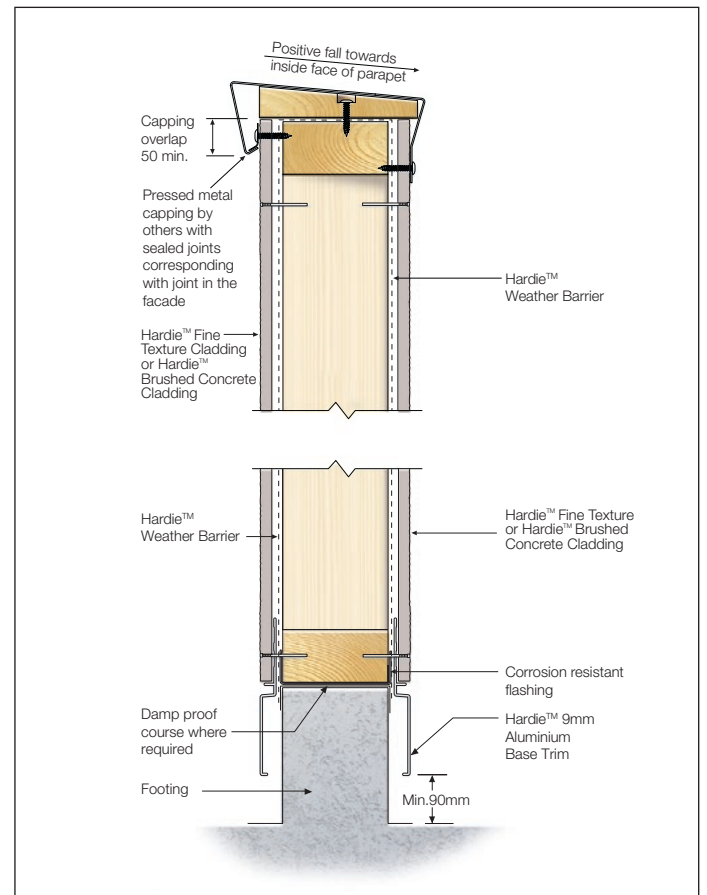

FIGURE 7 BLADE WALL

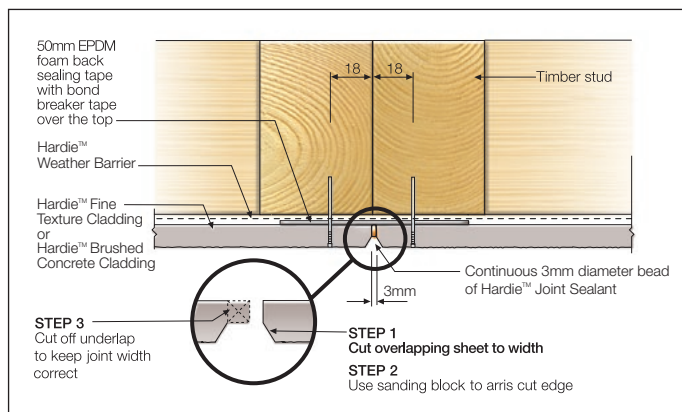

FIGURE 6 VERTICAL BUTT JOINT

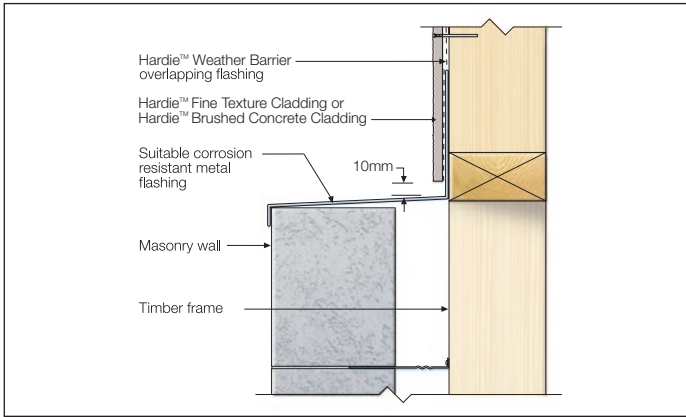

FIGURE 8 HORIZONTAL JUNCTION 2

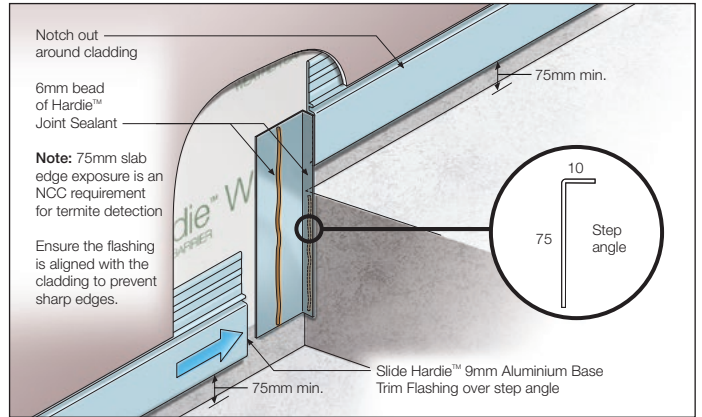

FIGURE 9 SLAB STEP OPTION

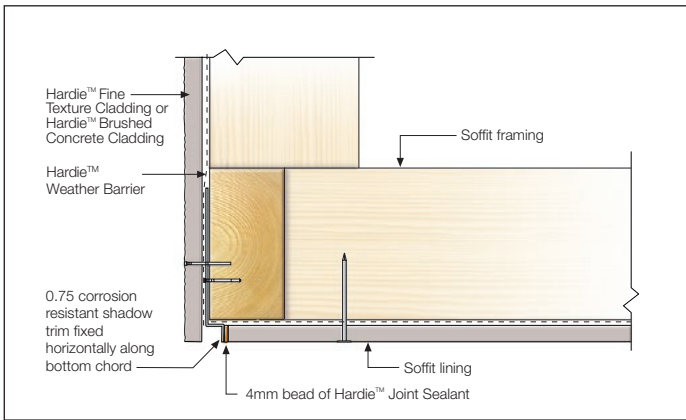

FIGURE 10 FACADE/SOFFIT JUNCTION

EXTERNAL CORNER DETAILS

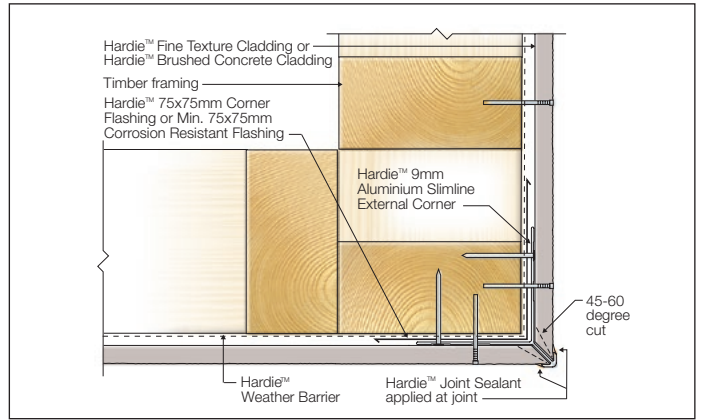

FIGURE 11 SLIMLINE CORNER OPTION

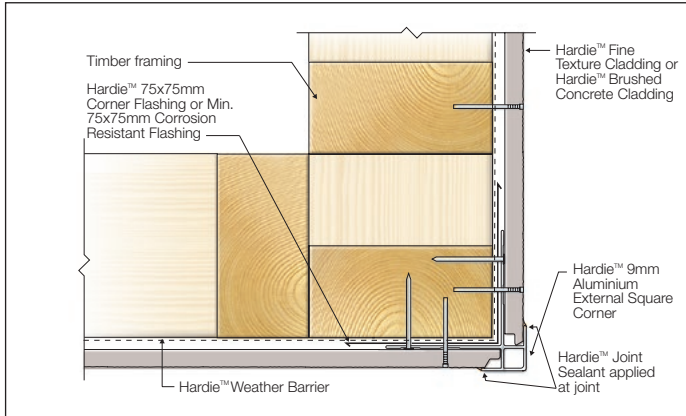

FIGURE 12 ALUMINIUM SQUARE CORNER OPTION

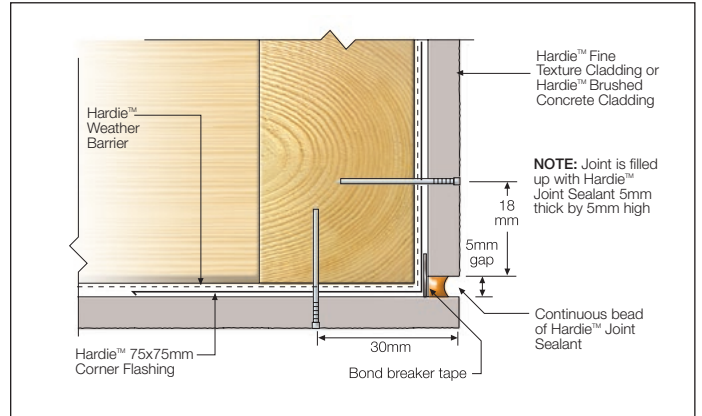

FIGURE 13 SEALANT FILL OPTION

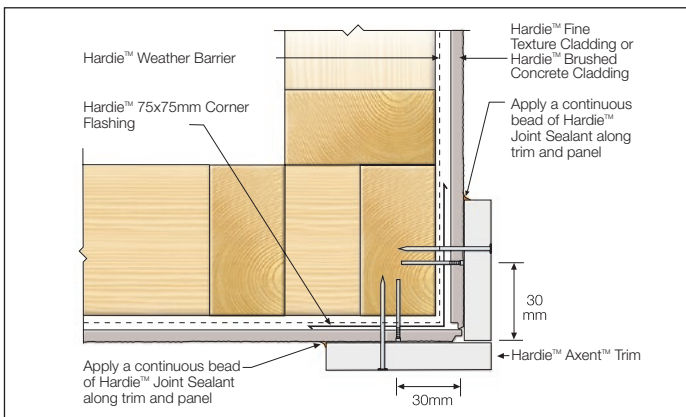

FIGURE 14 TRIM CORNER OPTION

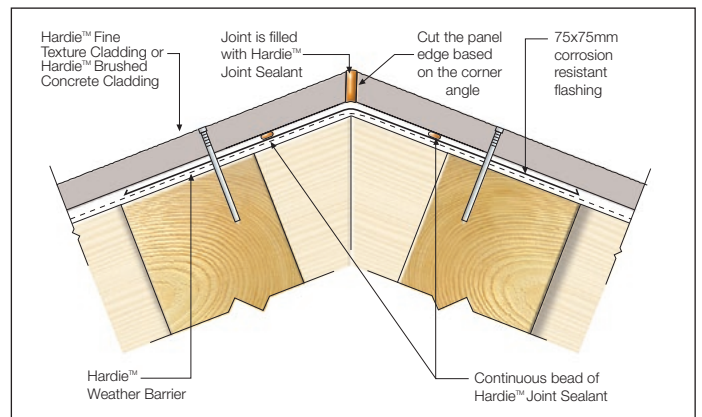

FIGURE 15 SEALANT FILL OPTION - MORE THAN 90° EXTERNAL CNR

INTERNAL CORNER DETAILS

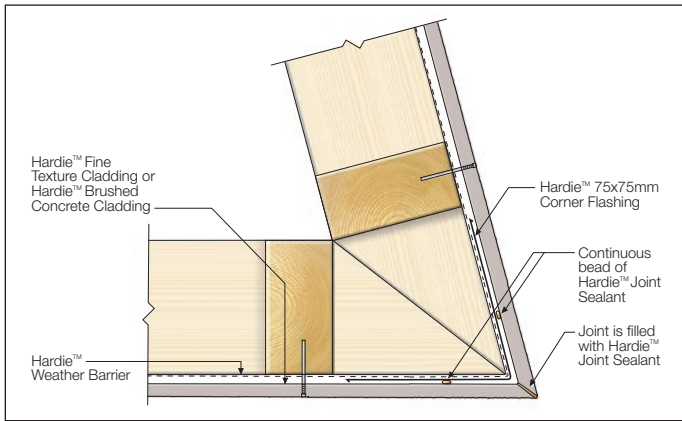

FIGURE 16 SEALANT FILL OPTION - LESS THAN 90° EXTERNAL CNR

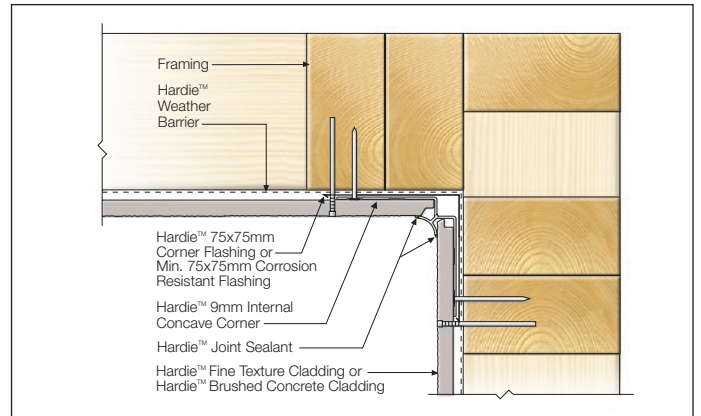

FIGURE 17 ALUMINIUM CORNER DETAIL

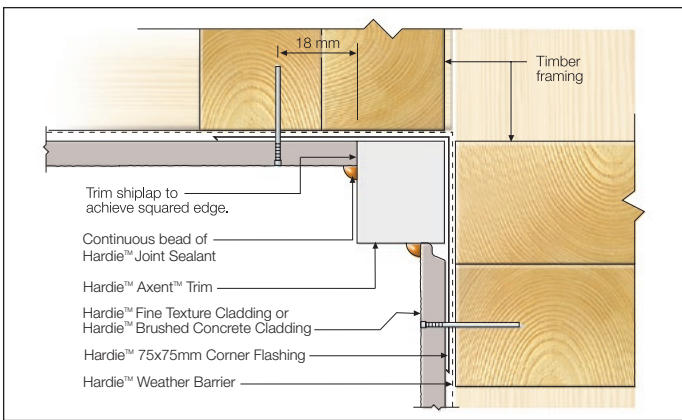

FIGURE 18 TRIM CORNER OPTION

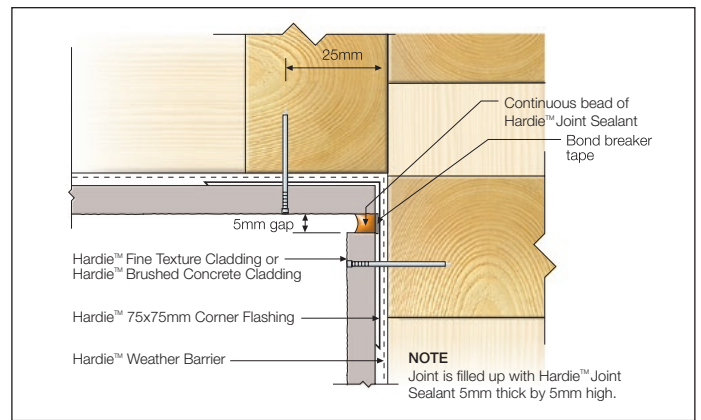

FIGURE 19 SEALANT FILL OPTION

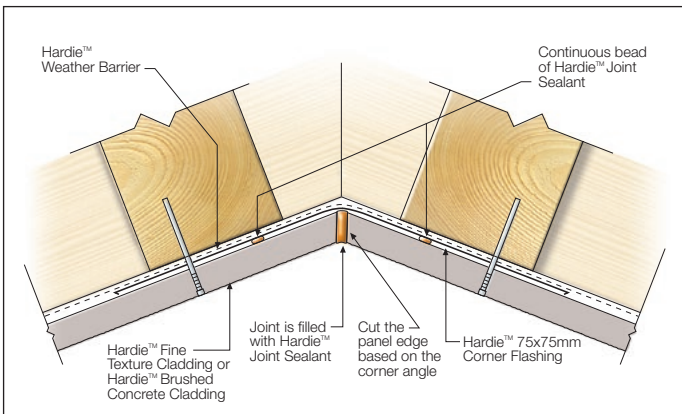

FIGURE 20 SEALANT FILL OPTION - LESS THAN 90° INTERNAL CNR

WINDOW DETAILS

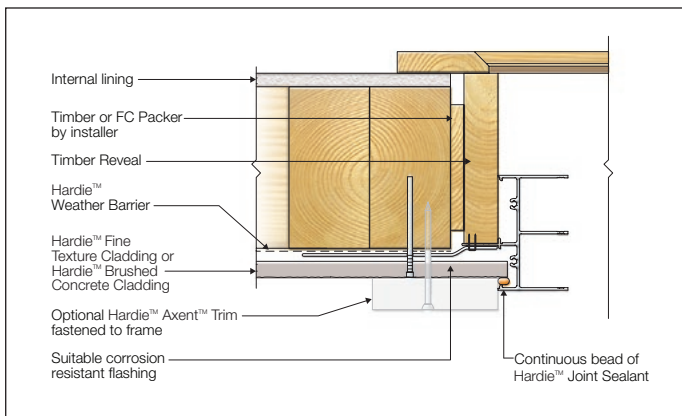

FIGURE 21 WINDOW JAMB - TRIM

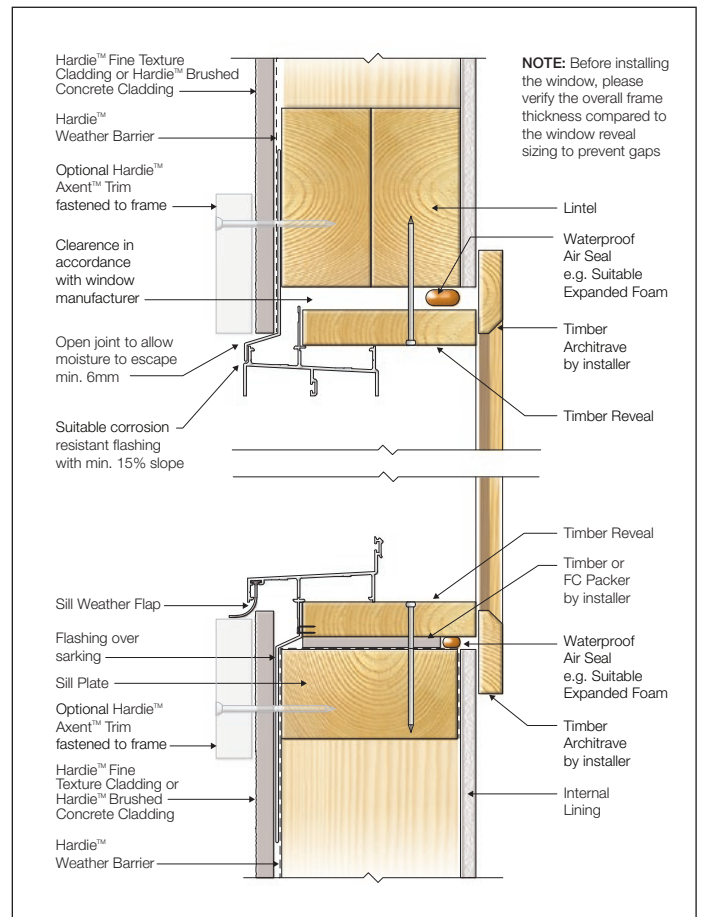

FIGURE 22 WINDOW HEAD AND SILL - TRIM

9 Construction Details - Cavity Fix

JUNCTION DETAILS

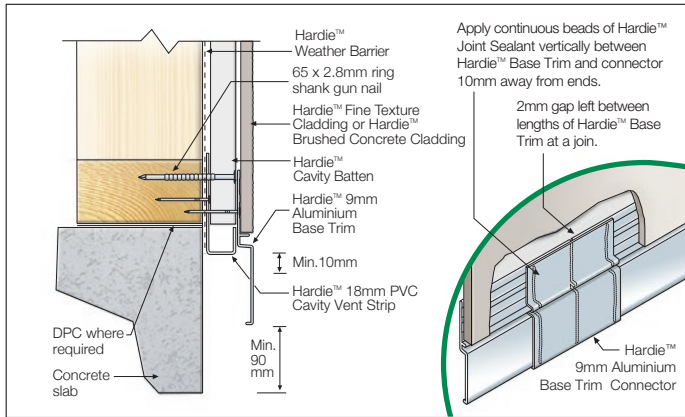

FIGURE 23 SLAB EDGE DETAIL

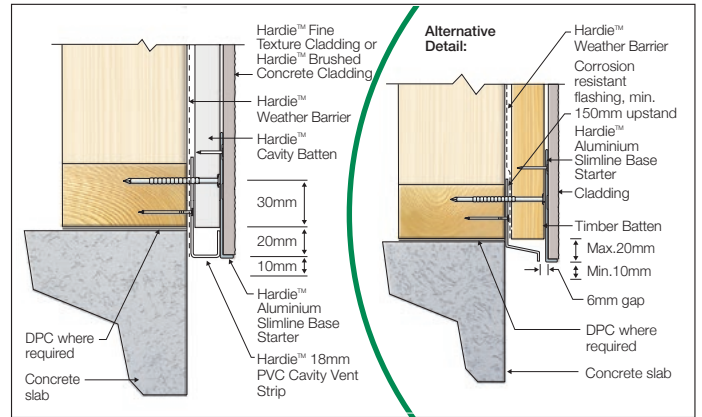

FIGURE 24 ALTERNATIVE SLAB EDGE DETAILS

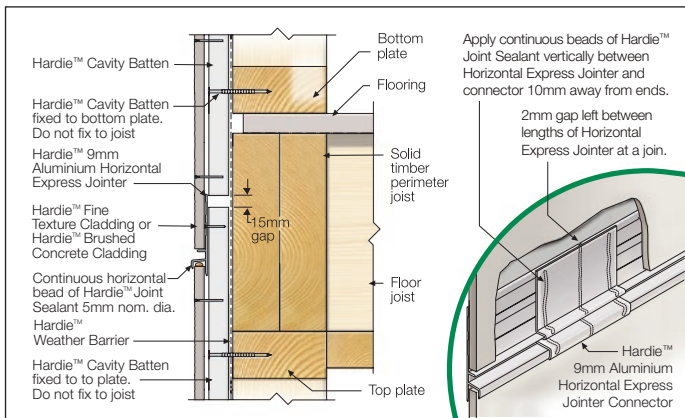

FIGURE 25 FLOOR LEVEL JUNCTION HORIZONTAL EXPRESS JOINTER

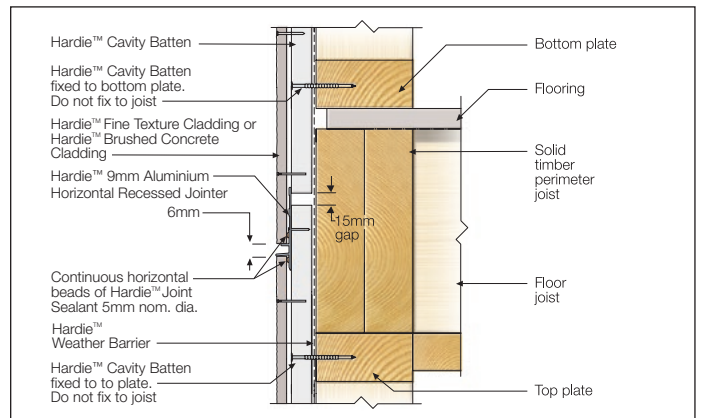

FIGURE 26 FLOOR LEVEL JUNCTION HORIZONTAL RECESSED JOINTER OPTION

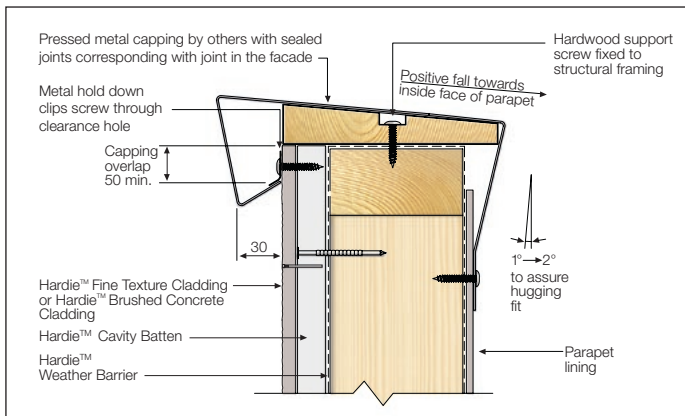

FIGURE 27 PARAPET CAPPING DETAIL

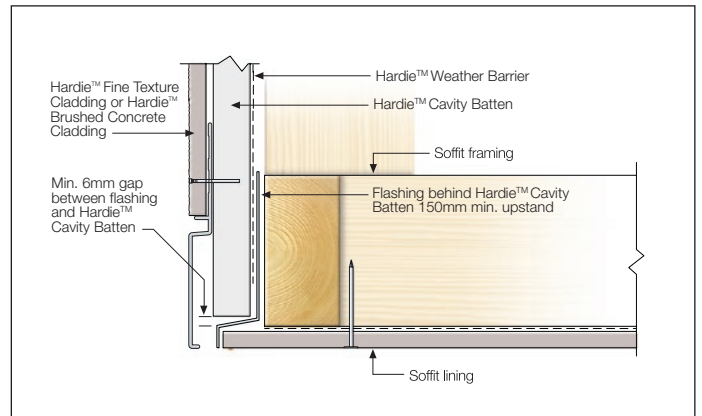

FIGURE 28 FACADE/SOFFIT JUNCTION

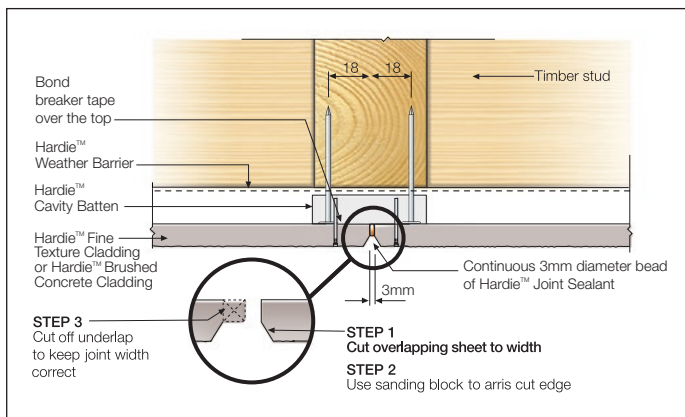

FIGURE 29 VERTICAL BUTT JOINT

EXTERNAL CORNER DETAILS

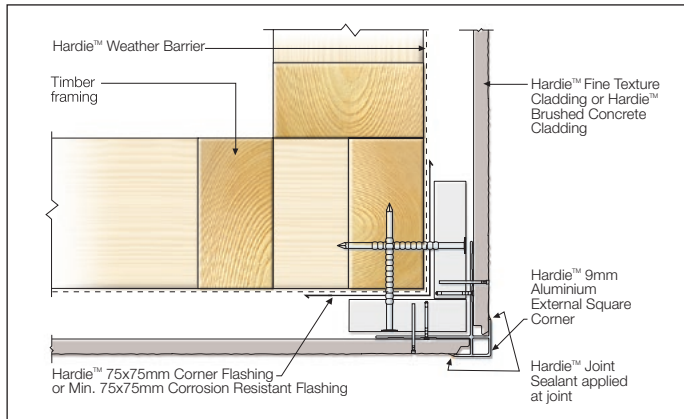

FIGURE 30 ALUMINIUM SQUARE CORNER OPTION - CAVITY BATTEN

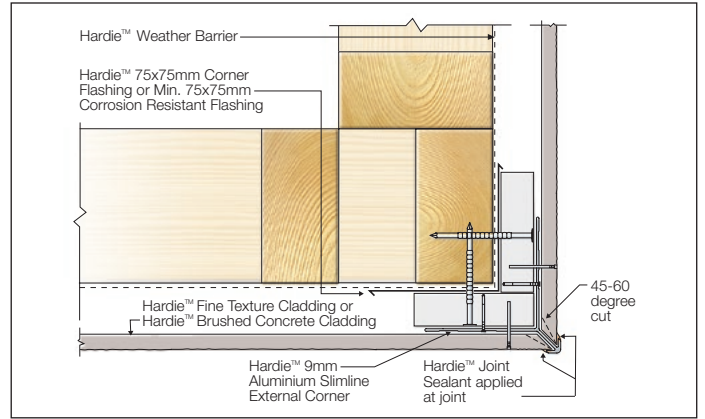

FIGURE 31 SLIM CORNER OPTION - CAVITY BATTEN

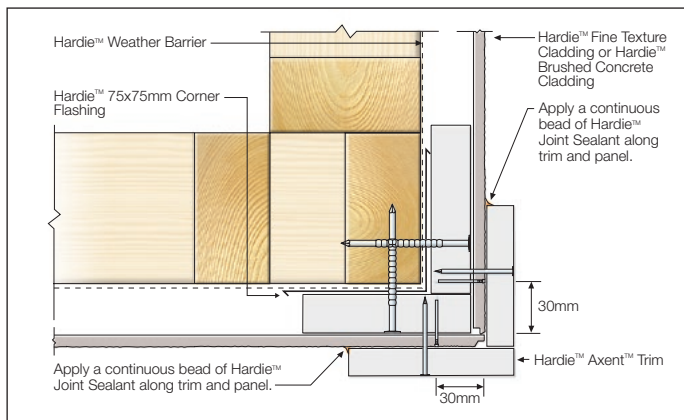

FIGURE 32 TRIM CORNER OPTION - CAVITY BATTEN

INTERNAL CORNER DETAILS

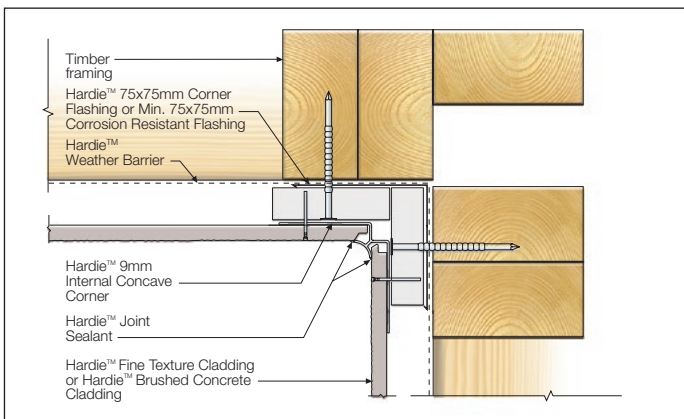

FIGURE 33 ALUMINIUM CORNER DETAIL - CAVITY BATTEN

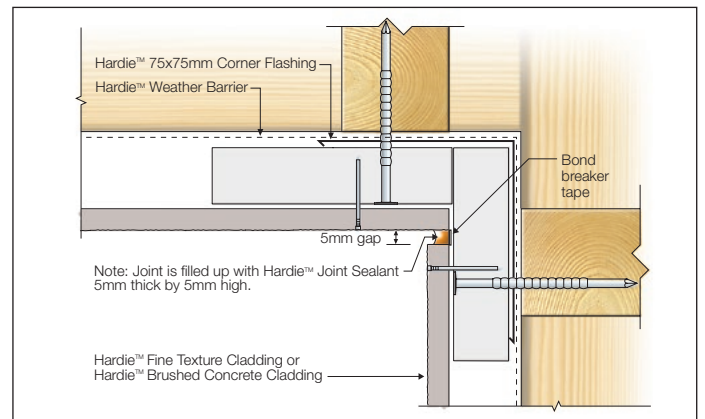

FIGURE 34 SEALANT FILL OPTION - CAVITY BATTEN

WINDOW DETAILS

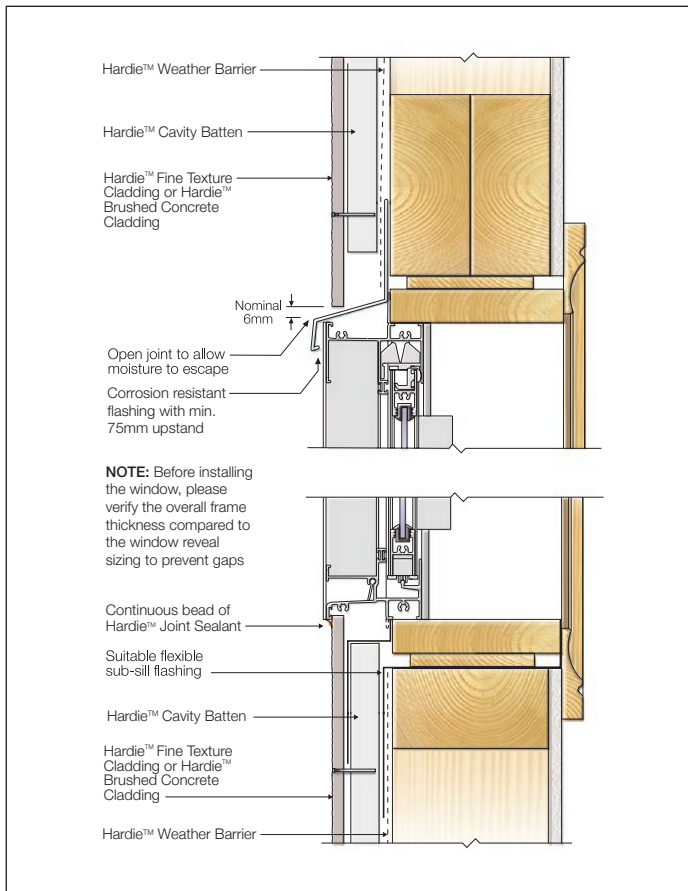

FIGURE 35 WINDOW HEAD AND SILL - CAVITY BATTEN

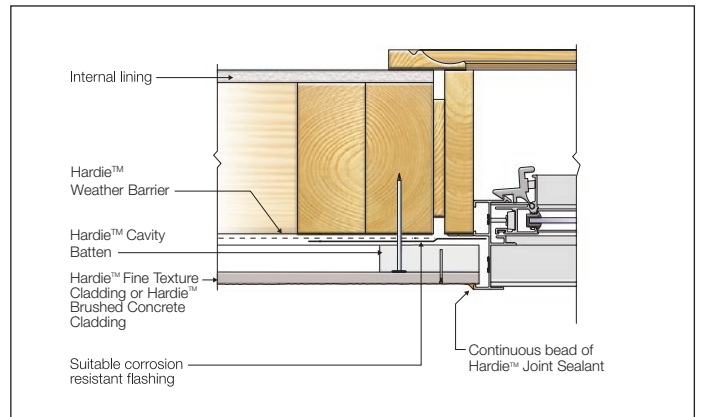

FIGURE 36 WINDOW JAMB - CAVITY BATTEN

INFILLS

Where Hardie™ Fine Texture Cladding or Hardie™ Brushed Concrete Cladding is to be used as an infill piece, such as above garage or porticos, refer to the figures below:

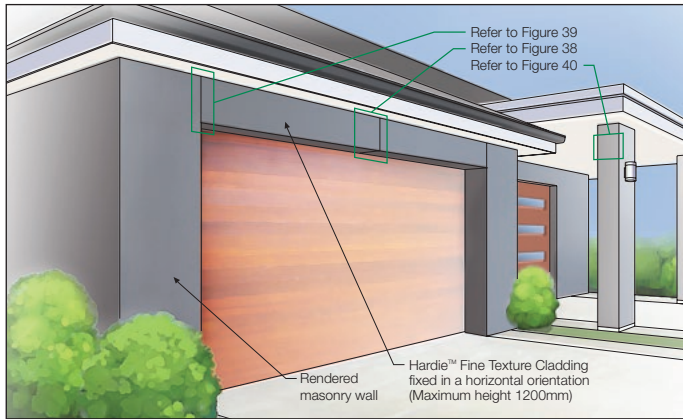

FIGURE 37 GARAGE DOOR DIAGRAM

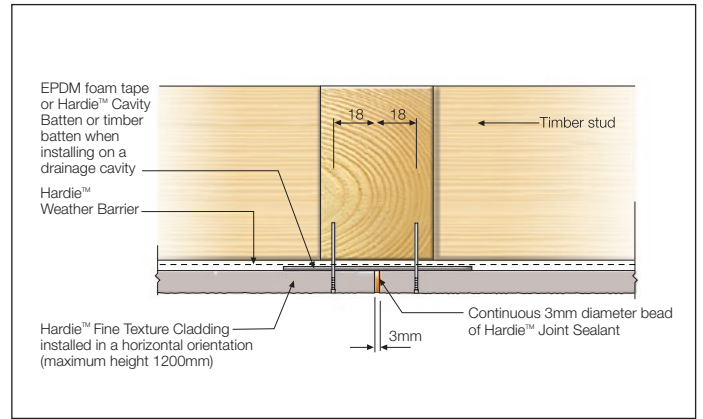

FIGURE 38 VERTICAL BUTT JOINT DIRECT FIX

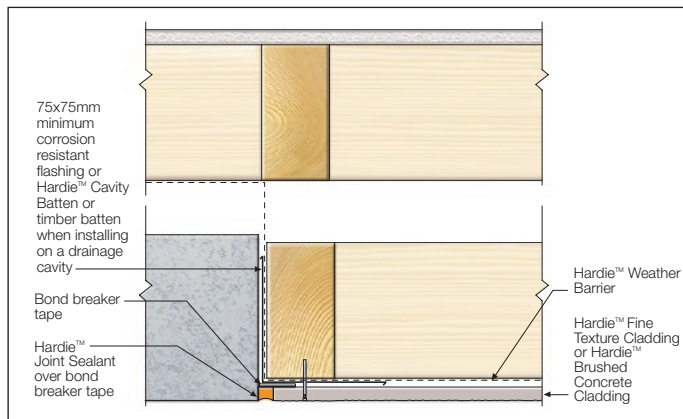

FIGURE 39 MASONRY (E.G. BRICK) ABUTMENT DETAIL

COLUMN

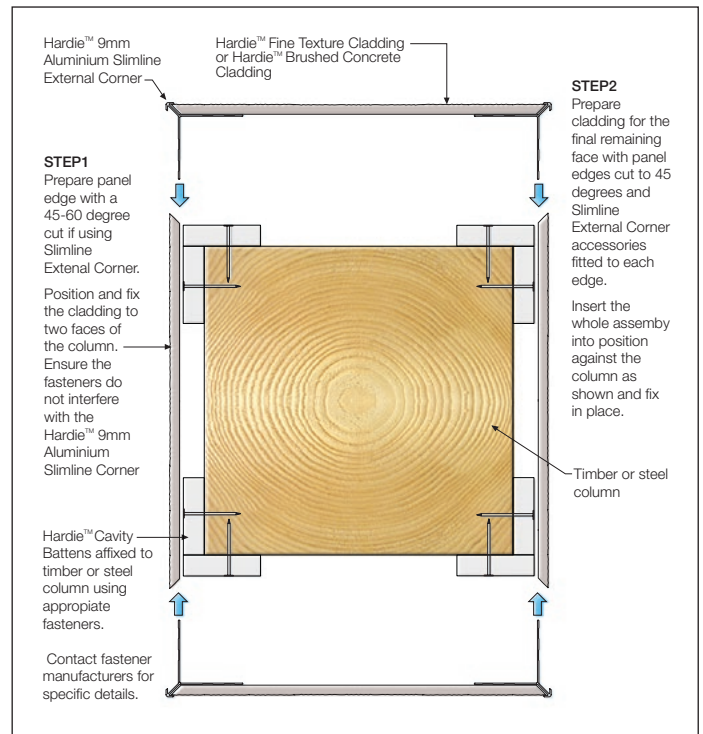

FIGURE 40 FIXING TO TIMBER OR STEEL COLUMN

10 Finishes and Maintenance

NAIL GUN SETUP

Preparation: Set up nail gun in accordance with manufacturers instructions.

Test: Use small piece of fibre cement and timber to test nail depth before installation of sheets. For best results, leave nail heads proud and carefully tap flush with a smooth hammer.

Check: If using a pneumatic hose, fit a pneumatic pressure gauge to ensure consistent firing pressure.

When installing Hardie™ Brushed Concrete, it is recommended to position the gun nail sideways so the square head brad nails are aligned with the texture.

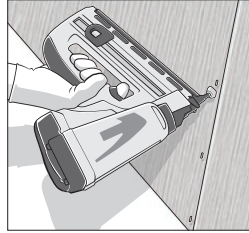

SURFACE PREPARATION AND PAINTING

Panels must be finished within 3 months of being fixed with the recommended coating set out in Table 5 and the project specification. In areas within 1km of a coastal area or corrosive environment, panels must be coated immediately after fixing sheets to minimise contamination build up on the heads of the fasteners.

To achieve best results, apply first coat of exterior acrylic paint, then assess patching requirements for any slightly overdriven brad nails (1mm max.)

Any slightly overdriven brad nails (1mm max.) can be repaired using an exterior grade, fibre cement compatible filling compound and following the below process:

1. Wearing appropriate gloves, place filling compound on finger and wipe over nail hole.
2. If there is excess of filling compound around the nail head, gently wipe away with a moist sponge or cloth before the compound sets.
3. Only when patching Hardie™ Brushed Concrete Cladding, any compound excess can be removed using a 120 grit angled sanding sponge in a vertical motion. When required, a folded piece of 120 grit sanding paper can be used for finer detailing in the valley areas of the panel.
4. Apply a second coat of exterior acrylic flat paint.

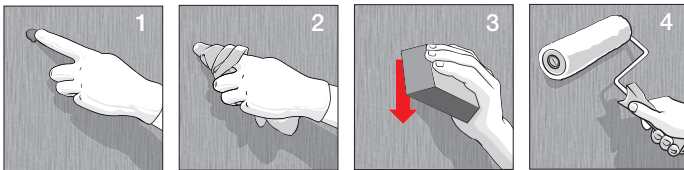

TABLE 5

Hardie™ Fine Texture Cladding and Hardie™ Brushed Concrete Cladding Finishing Requirements	
Flat Acrylic Paints	✓ Exterior acrylic flat paint. A nap roller of 12mm or greater is recommended for optimal finish. For best results, use low-sheen or matt finish exterior paints in natural colours.
Renders, Texture Coating & Joint Setting Systems	✗ Panels are pre-textured, they are not compatible with texture coatings and paints (e.g. Granosite and Rockcote systems).
Stains & Clear Sealers	✗ Semi-transparent stains can vary in uniformity of appearance depending on method of application and conditions and will require a high level of skill and craftsmanship to achieve a uniform appearance. Clear coats have not proven durable in exterior exposure and James Hardie considers them a maintenance item that may require application of a refurbishing sealer at regular intervals. James Hardie does not warrant the appearance or durability of semi-transparent stains and clear coats.

Joint Sealant

James Hardie recommends the use of Hardie™ Joint Sealant, which is a paintable polyurethane sealant. If using an alternative sealant, it must be a quality polyurethane sealant compatible with fibre cement and the specified paint system if coated. Please refer to the manufacturer's instructions for further information.

MAINTENANCE

The extent and nature of maintenance will depend on the geographical location and exposure of the building. As a guide, it is recommended that basic normal maintenance tasks shall include but not be limited to:

- Washing down exterior surfaces every 6-12 months*
- Periodic inspections should be made to ensure fasteners are adequately securing the sheets to framing.
- Re-applying of exterior protective finishes*
- Maintaining the exterior envelope and connections including joints, penetrations, flashings and sealants that may provide a means of moisture entry beyond the exterior cladding.
- Cleaning out gutters, blocked pipes and overflows as required.
- Pruning back vegetation that is close to or touching the building.

*Refer to your paint manufacturer for washing down and recoating requirements related to paint performance.

11 Product Information

PRODUCT INFORMATION

Material

The basic composition of Hardie™ fibre cement products is Portland cement, ground sand, cellulose fibre, water and proprietary additives.

Hardie™ fibre cement products are manufactured to AS/NZS 2908.2 'Cellulose-Cement Products-Flat Sheet'. These are also compliant with equivalent standard ISO 8336 'Fibre-cement flat sheets - Product specification and test methods'. For product classification refer to the relevant Physical Properties Data Sheet.

Durability

Resistance to Moisture/Rotting

Hardie™ Fine Texture and Brushed Concrete Cladding have demonstrated resistance to permanent moisture induced deterioration (rotting) by passing the following tests in accordance with AS/NZS 2908.2:

- Water permeability (Clause 8.2.2)
- Heat rain (Clause 6.5)
- Warm water (Clause 8.2.4)
- Soak dry (Clause 8.2.5)

Resistance to fire

Hardie™ Fine Texture and Brushed Concrete Cladding are suitable where non-combustible materials are required in accordance with C2D10 and H3D2 of the National Construction Code (NCC) Vol 1 and 2 respectively.

Fibre cement products manufactured by James Hardie have been tested by CSIRO in accordance with AS/NZS 3837 and are classified as conforming to Group 1 material (highest and best result possible), with an average specific extinction area far lower than the permissible 250m²/kg, as referenced in Specification C2D11(1) of the National Construction Code (NCC).

Resistance to Termite Attack

Based on testing completed by CSIRO Division of Forest Products and Ensis Australia, James Hardie's fibre cement building products have demonstrated resistance to termite attack.

Alpine Regions

In regions subject to freeze/thaw conditions, all fibre cement external cladding must be installed and painted in the warmer months of the year where the temperature does not create freeze and thaw conditions or paint issues. The cladding must be painted immediately after installation. In addition, fibre cement cladding must not be in direct contact with snow and/or ice build up for extended periods, e.g. external walls in alpine regions subject to snow drifts over winter.

Furthermore, a reputable paint manufacturer must be consulted in regards to a suitable product, specifications and warranty. The paint application must not be carried out if the air temperature or the substrate temperature is outside the paint manufacturer's recommendation including the specified drying temperature range

Fibre cement products manufactured by James Hardie are tested for resistance to frost in accordance with AS/NZS 2908.2 Clause 8.2.3.

12 Site Installation Checklist

USING THE CHECKLIST

Highlighting some key features of the Hardie™ Fine Texture and Brushed Concrete Cladding Installation Guide, this checklist has been created to assist you in the installation of Hardie™ Fine Texture and Brushed Concrete Cladding. Ensure all requirements of each stage are completed and marked as such before progressing to the next stage.

IMPORTANT: This checklist is not an exhaustive list of all compliance and construction requirements and it must only be used as a supplement to, and not a substitute for, compliance with the entirety of the Hardie™ Fine Texture Cladding and Hardie™ Brushed Concrete Cladding Installation Guide current at the time of installation. Please note, this checklist is for your own use, it is not to be submitted to James Hardie, and completion of this checklist does not evidence, and will not be accepted as being evidence of compliance with the Hardie™ Fine Texture Cladding and Hardie™ Brushed Concrete Cladding Installation Guide.

Project location: _____ Installer: _____
 Project Wind Category: N1, N2, N3/C1 | N4/C2 | N5/C5 | N6/C4 Fixing method: Direct to frame | Cavity - Cavity Trims | Cavity - Timber Battens
 Frame Material: Timber | Steel Stud/Batten Spacing (mm): 600 | 450 | 300 Sheet Fastener: _____
 Sheet Fastener Spacing (mm): 200 | 150 | 125 Corrosive environment: Yes - Less than 1km to coastal area | Yes - Other | No

Stage	Diagram	Requirement	Reference	Completed	Comments
Planning		Safe Working Practices Ensure you understand how to work safely with Fibre Cement.	Page 2	<input type="checkbox"/> YES <input type="checkbox"/> NO	
		Panel sizes Ensure optimal panel size is chosen based on wall height.	Page 6 - Item 1	<input type="checkbox"/> YES <input type="checkbox"/> NO	
		Vertical joint location Plan the location of vertical joints to align with the house design.	Page 8 and 9 - Step 1	<input type="checkbox"/> YES <input type="checkbox"/> NO	
		Window/door reveal sizing Verify overall frame thickness compared to window reveal sizing.	Page 12 - Fig 20-21 Page 15 - Fig 33-34	<input type="checkbox"/> YES <input type="checkbox"/> NO	
		Customized flashing dimensions Determine the geometry of flashings over openings.	Page 8 and 9 - Step 3	<input type="checkbox"/> YES <input type="checkbox"/> NO	
Framing Preparation		Stud spacing Verify the maximum stud spacing based on the projects wind category.	Page 4 - Table 3	<input type="checkbox"/> YES <input type="checkbox"/> NO	
		Noggin Spacing Ensure the noggins are within the maximum allowed.	Page 4 - Table 3	<input type="checkbox"/> YES <input type="checkbox"/> NO	
		Frame straightness Ensure the frame is square.	Page 8 and 9 - Step 2	<input type="checkbox"/> YES <input type="checkbox"/> NO	
		Ground Clearance Frame installed considering minimum distance to the ground.	Page 2 - Ground Clearance	<input type="checkbox"/> YES <input type="checkbox"/> NO	
		Flashing above window and openings All required flashings are installed over openings.	Page 8 and 9 - Step 3	<input type="checkbox"/> YES <input type="checkbox"/> NO	
Pre-Cladding		Windows/doors installed Windows and doors installed to manufacturers specification.	Page 12 - Fig 20-21 Page 15 - Fig 33-34	<input type="checkbox"/> YES <input type="checkbox"/> NO	
		Hardie™ Weather Barrier installation Installed in accordance with the product's installation guide.	Page 8 and 9 - Step 4	<input type="checkbox"/> YES <input type="checkbox"/> NO	
		EPDM over studs (direct fix only) EPDM tape applied over studs .	Page 8 - Step 5	<input type="checkbox"/> YES <input type="checkbox"/> NO	
		Cavity trims or timber battens (cavity fix only) Vertical battens installed .	Page 9 - Step 6	<input type="checkbox"/> YES <input type="checkbox"/> NO	
		Corner Installation Internal and external corner accessories installed.	Page 8 - Step 6 Page 9 - Step 7	<input type="checkbox"/> YES <input type="checkbox"/> NO	
		Horizontal trim installation Base trims and flashing installed to manufacturers specifications.	Page 8 - Step 7 Page 9 - Step 8	<input type="checkbox"/> YES <input type="checkbox"/> NO	

12 Site Installation Checklist cont.

Stage	Diagram	Requirement	Reference	Completed	Comments
Cladding Installation		Sealant applied over vertical battens (cavity fix only) Hardie™ Joint Sealant applied over vertical battens.	Page 9 - Step 9	<input type="checkbox"/> YES <input type="checkbox"/> NO	
		Fastener Spacing Fastener spacing within the maximum based on wind category.	Page 4 - Table 3	<input type="checkbox"/> YES <input type="checkbox"/> NO	
		Edge clearance Fasteners within the maximum distance from panel edges.	Page 8 - Step 8-9 Page 9 - Step 9-10	<input type="checkbox"/> YES <input type="checkbox"/> NO	
		Sealant over vertical joints All vertical joints sealed with Hardie™ Joint Sealant.	Page 8 - Step 9 Page 9 - Step 10	<input type="checkbox"/> YES <input type="checkbox"/> NO	
		Sealant behind corners All corners sealed with Hardie™ Joint Sealant.	Page 8 - Step 10 Page 9 - Step 10	<input type="checkbox"/> YES <input type="checkbox"/> NO	
Painting		Surface imperfections repaired All imperfections and over-driven nails are fixed.	Page 17 - Section 10	<input type="checkbox"/> YES <input type="checkbox"/> NO	
		Wall painted Wall painted within the maximum recommended time.	Page 17 - Section 10	<input type="checkbox"/> YES <input type="checkbox"/> NO	

Notes



**For information and advice
call 13 11 03 | jameshardie.com.au**

Australia October 2023

© 2023 James Hardie Australia Pty Ltd ABN 12 084 635 558
™ and ® denote a trademark or registered mark owned by James Hardie Technology Limited.
Colorbond®, Sellaes®, Polyfilla®, Hitachi, Makita®, Taubmans®, Watty® and Hilti are trademarks or registered
trademarks of their respective owners and are not owned by James Hardie Technology Limited.

